

## 3/2 way Miniature Rocker Solenoid Valve for pneumatic systems

- Direct-acting
- High cycling rate
- Reduced power consumption
- CNOMO and Bürkert flange interface
- ATEX Ex ia on request

Type 6106 can be combined with...



**Type 2506**

Cable plug

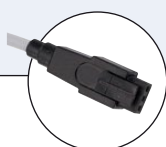

**Type 2505**

Rectangular cable plug



**Manifolds**

The direct-acting rocker solenoid valve type 6106 is especially designed for neutral gaseous mediums.

The heat input in the medium is minimal, because the housing is separated from the coil by a stainless steel plate.

The valves can be mounted directly or also single or manifold mounted. They are used for dosing, filling, mixing and distributing small quantities of medium.

### Circuit function C

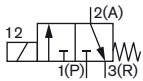

3/2 way direct-acting solenoid valve, normally closed

### Circuit function D

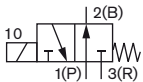

3/2 way direct-acting solenoid valve, normally open

### Technical data

<b>Orifice</b>	DN0.9 and 1.2 mm, other on request
<b>Body material</b>	PA (polyamide)
<b>Seal material</b>	FKM
<b>Media</b>	Compressed air, neutral gases (5 µm filtering) technical vacuum
<b>Media temperature</b>	- 10 to + 55 °C
<b>Ambient temperature</b>	- 10 to + 55 °C
<b>Port connection</b>	Bürkert flange below, CNOMO flange sideways
<b>Operating voltages</b>	12 V, 24 V DC, other voltages on request
<b>Voltage tolerance</b>	± 10%
<b>Power consumption</b>	1 W and 2 W
<b>Cycling rate</b>	Approx. 1000/min
<b>Duty cycle</b>	100% continuous rating
<b>Electrical connection</b>	Tag connector sideways acc. to DIN EN 175301-803 (prev. DIN 43650) Form C for cable plug Type 2506, other on request
<b>Protection class</b>	IP20 with tag connector, IP65 with cable plug
<b>Installation</b>	As required, preferably with actuator upwards
<b>Response times</b>	acc. ISO 12238:2001; Measured at valve outlet at 6.3 bar and + 20 °C
Opening	Approx. 25ms (pressure rise 0 to 10%)
Closing	Approx. 25ms (pressure rise 100% to 10%)

## Ordering chart for valves (other versions on request)

All valves with manual override, tag connector sideways, mounting screws and flange seal, without cable plug

Circuit function	Port connection	Orifice [mm]	$Q_{Nn}$ value air 1→2 [l/min]	$Q_{Nn}$ value air 2→3 [l/min]	Pressure range [bar]	Power consumption [W]	Article no. per voltage/frequency [V/Hz]
<b>C</b> 3/2 way valve NC 	Bürkert	0.9	22	25	Vac.-8	1	126417
	Bürkert	1.2	40	47	Vac.-10	2	126411
<b>D</b> 3/2 way valve NO 	Bürkert	0.9	22	25	Vac.-8	1	126421
	Bürkert	1.2	40	47	Vac.-10	2	126419
<b>C</b> 3/2 way valve NC 	CNOMO	0.9	22	25	Vac.-8	1	126418
	CNOMO	1.2	33	38	Vac.-10	2	126414
<b>D</b> 3/2 way valve NO 	CNOMO	0.9	22	25	Vac.-8	1	126422
	CNOMO	1.2	33	38	Vac.-10	2	126420

**Note:** For alternating current, use a cable plug with a suitable rectifier.

**Please note** that the cable plug has to be ordered separately, see datasheet for Type 2506.

### Weitere Ausführungen auf Anfrage

**Port connection**  
Flange, Cnomo, plug-in coupling, tube body

**Approvals**  
ATEX EEX I, UL /CSA

**Electrical connections**  
Industrial plug C, Bürkert Rectangular plug, Circular connector M8 ; flying leads

**Note:** Also available as an option without manual override.

## Dimensions [mm]

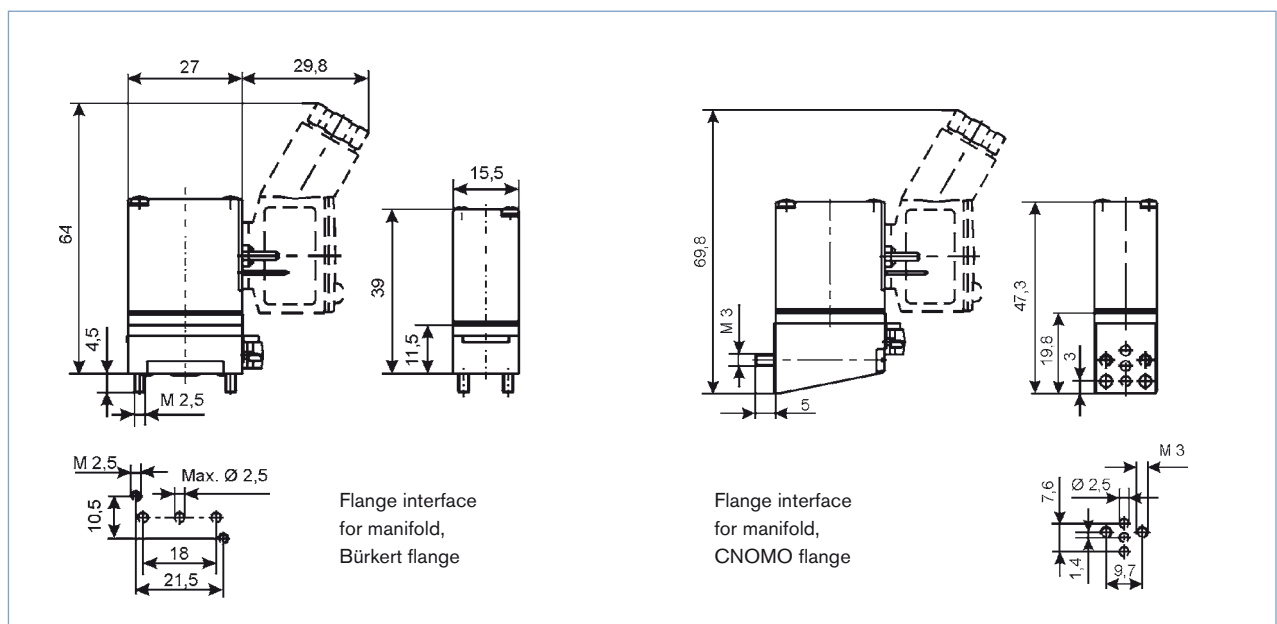

Single manifolds for Bürkert flange [mm]

Manifold in aluminium, black anodised, port connection M5

**Article no.**  
623873

Manifold in aluminium, black anodised, port connection G 1/8

**Article no.**  
634917

Multiple manifolds for Bürkert flange 3-way [mm]

Manifold in aluminium, black anodised, port connection G 1/8 und M5

Manifold	A	B	n	Article no.
2-way	60	18	2	658695
3-way	78	36	3	658696
4-way	96	54	4	658697
5-way	114	72	5	658698
6-way	132	90	6	658699
8-way	168	126	8	658700
10-way	204	162	10	658701
12-way	240	198	12	658703
Blanking plate kit	for non-configured valve positions			629327

DTS 1000011046 EN Version: E Status: RL (released | freigegeben | valide) printed: 23.01.2018

Single manifolds for CNOMO flange [mm]

Manifold for CNOMO flange, black anodised, port connection M5

**Article no.**  
639885

Mounting kit, complete for standard rail TS35 x 7.5 mm

**Article no.**  
629254





Multiple manifolds CNOMO flange 3-way

Manifold in aluminium, black anodised, port connection G 1/8 and M5







Manifold	L	Article no.
2-way	33	639887
3-way	49.5	639862
4-way	66	639863
5-way	82.5	639864
6-way	99	639865
8-way	132	639866
10-way	165	639867
12-way	198	639868
Blanking plate kit	for non-configured valve positions	639695

## Ordering chart for accessories

Cable plug type 2506 acc. DIN EN 175301-803 form C, with flat seal and mounting screw, without cable

	<b>Cable plug type 2506</b>	<b>Voltage</b>	<b>Article no.</b>
	without circuitry	0 - 250 V AC+DC	008353 
	with LED	12 - 24 V DC	008402 
	with LED and varistor	12 - 24 V DC	008408 
	with rectifier, LED and varistor	12 - 24 V AC+DC	008354 

Cable plug type 2505

	<b>Type 2505 cable version</b>	<b>Article no.</b>
	with 3 m cable	133486 
with 5 m cable	167494 	
	<b>Type 2505 flying leads version</b>	<b>Article no.</b>
	with 300 mm flying leads	644068 
	with 600 mm flying leads	162144 

## Application examples

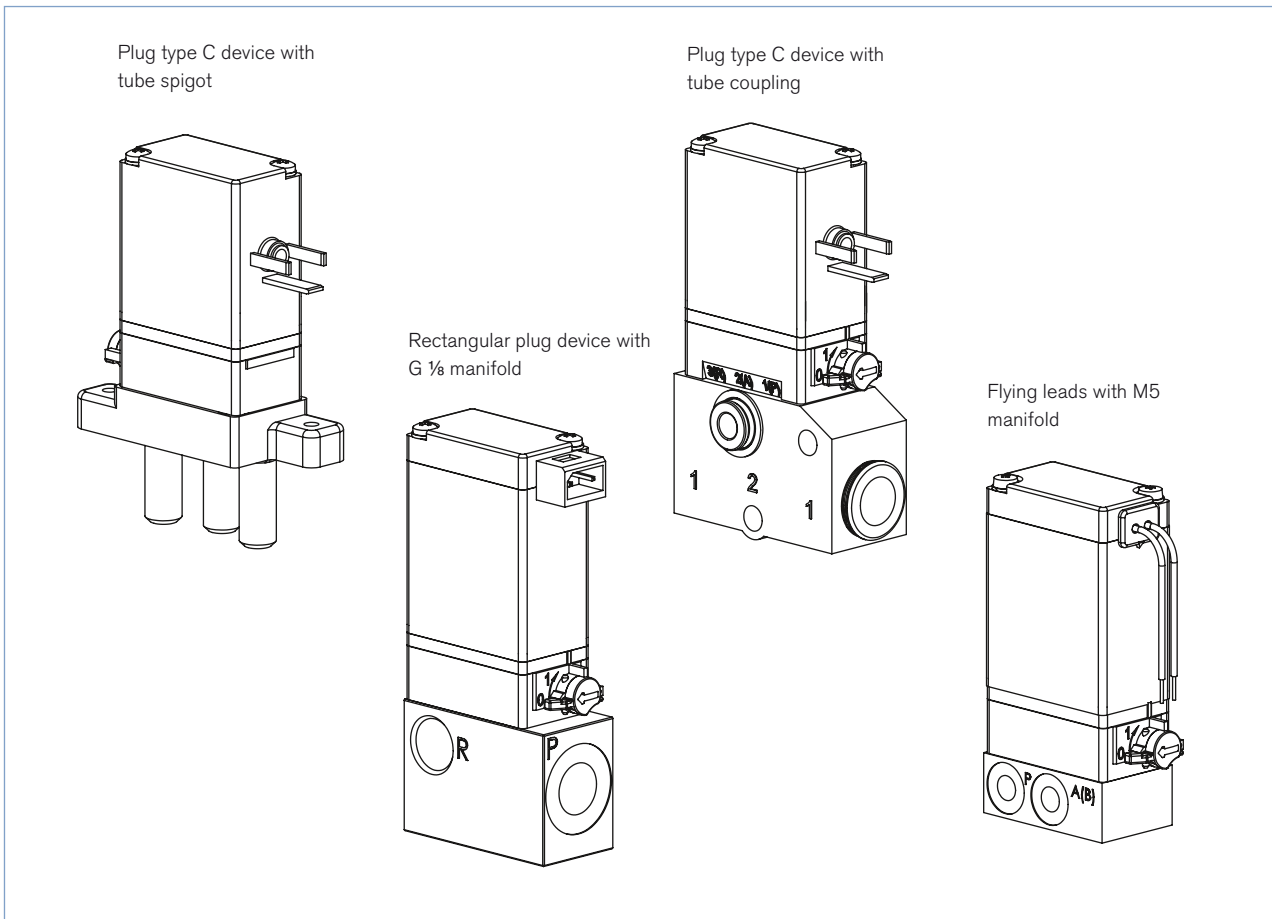

To find your nearest Bürkert facility, click on the orange box



[www.burkert.com](http://www.burkert.com)

In case of special application conditions,  
please consult for advice.

Subject to alterations  
© Christian Bürkert GmbH & Co. KG

1801/3\_EU-en\_00891743